

## Installation and Operating Instructions

---

### Video Intercom System — Room Monitor

Model No. **VL-MN1000**



Thank you for purchasing a Panasonic product.

Please follow all instructions in this document and save it for future reference.

Carefully read the information found in the section titled "2.1 Important safety information" in particular.

This system is an auxiliary system; it is not designed to provide complete protection from property loss. Panasonic will not be held responsible in the event that property loss occurs while this system is in operation.

#### Note to the installer

- **This document includes instructions for both installation and operation. See the section titled "12 Installation" for installation instructions.**
- Please read this document carefully, and install the product safely and correctly by following the instructions.
- Only use attachments/accessories specified by the manufacturer.
- The installation shall be carried out in accordance with all applicable installation rules.

## 1. Introduction

1.1	System overview .....	3
1.2	About this document .....	3

## 2. Important information

2.1	Important safety information .....	4
2.2	Important safety instructions .....	4
2.3	Privacy and rights of portrait .....	5
2.4	Data security .....	5
2.5	For best performance .....	5
2.6	Disclaimer .....	5
2.7	Other important information .....	6
2.8	General information .....	6
2.9	For India only .....	7
2.10	For Europe .....	7

## 3. Preparation

3.1	Device diagrams .....	8
3.2	Home screen .....	9
3.3	Feature screens .....	10
3.4	Status icons .....	10
3.5	Main vs. sub room monitors .....	11

## 4. Talking and monitoring features

4.1	Difference between talking and monitoring .....	12
4.2	Answering calls .....	12
4.3	Making calls .....	13
4.4	Transferring calls .....	14
4.5	Monitoring camera images .....	14
4.6	Viewing call log .....	15

## 5. Playback and messaging features

5.1	Playing video messages from visitors .....	16
5.2	Playing videos you recorded .....	16
5.3	Controlling video playback .....	17
5.4	Viewing pictures .....	17
5.5	Viewing text messages from facility staff .....	18
5.6	Playing voice messages from facility staff .....	18

## 6. Alarm features

6.1	Alarm features overview .....	19
6.2	Changing the arm mode .....	19
6.3	Configuring each arm mode .....	20
6.4	Changing alarm feature settings .....	20
6.5	Confirming alarm feature status and settings .....	21

6.6	Viewing the alarm log .....	21
-----	-----------------------------	----

## 7. Phonebook features

7.1	Viewing the phonebook .....	22
7.2	Adding entries .....	22

## 8. Room monitor settings

8.1	Changing the room monitor's settings .....	23
8.2	List of settings .....	23

## 9. Lobby station features

9.1	Lobby station overview .....	25
9.2	Lobby station operations .....	25

## 10. Troubleshooting

10.1	Troubleshooting .....	26
10.2	Error messages .....	27

## 11. Other information

11.1	Specifications .....	28
11.2	Cleaning .....	29
11.3	Open source software notice .....	29

## 12. Installation

12.1	Included items .....	30
12.2	Optional items .....	30
12.3	Installation cautions .....	31
12.4	Information about power connection .....	31
12.5	Power over Ethernet (PoE) connection .....	31
12.6	Installing the power supply unit (sold separately) .....	31
12.7	Installing the room monitor .....	34
12.8	Connecting external devices .....	37
12.9	Wiring schematic .....	38
12.10	Wire and cable specifications .....	38
12.11	Initial setup for room monitors .....	39

## 1.1 System overview

This document explains basic information required to install, configure, and use a VL-MN1000 Room Monitor for use with a Video Intercom System that is comprised of the following devices.

- VL-MN1000 Room Monitor
- VL-VN1900 Lobby Station
- VL-VN1500 Door Station
- VL-VN1700 Control Box

### 1.1.1 Main features

Features described here may require additional hardware installed at your residence, and may not be available depending on your facility's system configuration. For more information, consult your facility staff.

#### Camera features

- When a visitor calls you, you can confirm who the visitor is before talking or opening the door. Pictures can be captured automatically, allowing you to see who visited you while you were out.
- When a visitor calls you using a lobby station, the visitor can record a video message for you if you don't answer.
- You can monitor cameras installed throughout the complex, such as the garage, pool, common areas, etc.

#### Alarm features

- External devices connected to your room monitors can notify facility staff and/or residents when triggered, such as in the event of a gas leak, water leak, etc.
- If an emergency button is connected to your room monitor, you can call facility staff quickly and easily in the event of an emergency.

#### Other features

- You can use your room monitor to call other residents.
- Up to 5 room monitors can be installed in your residence. You can make and answer calls from any of the room monitors, and use them as your own personal intercom system.
- Facility staff can send messages (text or voice, depending on system configuration) to your room monitors for quick information dispersal.

## 1.2 About this document

### Symbols, expressions, and styles

The following symbols, expressions, and styles are used in this document.

Item	How it is expressed
Text displayed on the product's display	Text is displayed in a special font, usually enclosed in quotation marks. <b>Example:</b> "Settings"
Icons displayed on the product's display that have no text label	Black-and-white illustration of icon is used. <b>Example:</b> 
Buttons with printing on them	Button printing is displayed, usually wrapped in thick brackets. <b>Example:</b> [ «» ]

### Terms and illustrations

- Model number suffixes (e.g., the "BX" in "VL-MN1000BX") are omitted unless necessary.
- Design and specifications are subject to change without notice.
- Illustrations may vary slightly from the actual product.

### Trademarks

- The software of this product is based in part on the work of the Independent JPEG Group.
- All other trademarks identified herein are the property of their respective owners.

## 2. Important information

### 2.1 Important safety information

To prevent severe injury or loss of life or property, and to ensure proper and safe operation of your product, read this section carefully before using the product.

#### Note:

- If you are connecting a VL-PS240 power supply unit to the product, refer to the documentation included with the power supply unit for additional safety information.



#### 2.1.1 Preventing fire, electric shock, and short circuits

- Do not disassemble or modify the product. Refer servicing to an authorised service centre when service is required. Disassembling the product or manipulating the product in a way not described in the documentation may expose you to dangerous voltages and other risks.
- Do not touch the product or the power supply unit during an electrical storm. There may be a remote risk of electric shock from lightning.
- Do not push any objects through the openings of the product.
- If any of the following conditions occur, disconnect the Ethernet (LAN) cable from the product, disconnect the power supply unit from the power outlet, and then refer servicing to an authorised service centre.
  - The product emits smoke, an abnormal smell or makes unusual noise
  - The power cables are damaged or frayed
  - Metal objects have been dropped inside the product

#### For installation

- **Leave installation work to the dealer. Installation work requires technical knowledge and experience. Electrical connection work should be performed by certified personnel only. Failure to observe this may cause fire, electric shock, injury, or damage to the product. Consult the dealer.**
- Do not disassemble or modify the product. Refer servicing to an authorised service centre when service is required. Disassembling the product or manipulating the product in a way not described in the documentation may expose you to dangerous voltages and other risks.
- Never install wiring during a lightning storm.
- Do not connect non-specified devices.
- When opening holes in walls for installation or wiring, or when securing the power cable, make sure you do not damage existing wiring and ductwork.

- Do not make any wiring connections when the power outlet is turned on.
- Do not install the product and power supply unit in the following places:
  - Places where the product and power supply unit may be splashed with water or chemicals
  - Places where there is a high concentration of dust or high humidity
- When existing wires are used, it is possible that they contain AC voltage. Contact an authorised service centre.



#### 2.1.2 Preventing accidents, injuries, and property damage

- Do not use the product in unstable areas or areas prone to strong vibrations. This may cause the product to fall, resulting in damage to the product or injury.
- Do not put your ear(s) near the speaker, as loud sounds emitted from the speaker may cause hearing impairment.

#### For installation

- If the wiring passes outdoors, use a conduit and a surge protector.
- If the wiring passes underground, use a conduit, and do not make any connections underground.
- Install the product securely adhering to the instructions in this document to prevent it from falling off the wall. Avoid installing onto low-strength walls, such as gypsum board, ALC (autoclaved lightweight concrete), concrete block, or veneer (less than 18 mm thick) walls.

### 2.2 Important safety instructions

When using this product, basic safety precautions should always be followed to reduce the risk of fire, electric shock, or personal injury.

1. Do not use this product near water. For example, near a bathtub, wash bowl, kitchen sink, or laundry tub, in a wet basement, or near a swimming pool, and the like.
2. Use only the power supply unit indicated in this document.

#### SAVE THESE INSTRUCTIONS

---

---

### 2.3 Privacy and rights of portrait

When installing or using the product, please take into consideration the rights of others with regard to privacy.

- It is generally said that "privacy" means the ability of an individual or group to stop information about themselves from becoming known to people other than those whom they choose to give the information. "Rights of portrait" means the right to be safe from having your own image taken and used indiscriminately without consent.

---

---

### 2.4 Data security

In order to use the system safely and correctly, the data security guidelines (listed below) must be observed. Failure to do so may result in the following.

- Loss, leakage, falsification or theft of user information.
- Unauthorised or illegal use of the system by a third party.
- Interference or suspension of service caused by a third party.

#### What is user information?

User information is defined as the following types of information.

- Information stored in the product
  - System event information
  - Messages and camera images
  - Resident names and room numbers
  - System and device settings
- Information stored on the computer that is used by the setup tool
  - Resident names and room numbers
  - System and device settings

#### Data security guidelines

- **Observe proper management of passwords.**
  - Passwords can be used to program the system, open doors, etc. Select passwords that are difficult to guess, change them regularly, and keep them secret. Assign a unique password to each device.
- **Use caution when entering or saving contact information for use by the system.**
  - When configuring email addresses, room numbers, or other contact information, make sure all information is entered correctly. Incorrect information could cause user information to be disclosed to unintended recipients.
- **Protect user information when sending the product to be repaired, or when handing it over to a third party.**
  - Use the product's reset function to initialise the product before when sending the product to be repaired or handing it over to a third party.
  - Note that user information may be deleted or initialized when the product is repaired.

- Refer all repairs to a trusted Panasonic service centre.
- **Protect user information stored on the computer used to configure the system.**
  - When user information is stored on a computer, the confidentiality of that information becomes the responsibility of the installer. Take precautions to prevent the unauthorised use of the computer and the setup tool used for performing system configuration or maintenance.
  - Connect the computer to the network only when performing system configuration or maintenance, and disconnect the computer from the network as soon as the work is complete.
  - Before disposing of the computer, ensure that data cannot be retrieved from it by formatting the hard disk and/or rendering it physically unusable.
- **Protect user information when disposing of the product.**
  - Use the product's reset function to initialise the product before disposing of the product.

---

---

### 2.5 For best performance

#### Environment

- The product should not be exposed to direct sunlight.
- The product should be kept away from heat sources such as radiators, cookers, etc. It should not be placed in rooms where the temperature is less than 0 °C or greater than 40 °C. Damp basements should also be avoided.
- Do not install the product in locations that are suspect to sudden changes in temperature. Failure to do so may cause condensation to form on the product causing malfunction.
- In areas surrounded by a high electrical field, disturbances may occur in the product's image or sound.

---

---

### 2.6 Disclaimer

- Recorded data may be altered or deleted as a result of incorrect operations, exposure to static electricity, accidents, malfunction, repairs or other operations. Panasonic assumes no liability for any direct or indirect damages resulting from the loss or alteration of recorded data.
- To the maximum extent permitted by law, Panasonic assumes no responsibility for injuries or property damage resulting from failures arising out of improper installation or operation inconsistent with this document.

## 2. Important information













### 2.7 Other important information

- When you leave the product unused for a long period of time, unplug it from the power outlet.
- If you stop using this product, remove it from the walls to prevent it from falling off.
- When power fails, this product cannot be used.
- Panasonic may not be liable for damages due to external factors such as power failures.
- The recorded images may be lost when:
  - Mishandled
  - Electric shock or radio wave interference occurs.
  - The power is turned off during use.

### 2.8 General information

- In the event of problems, you should contact your equipment supplier in the first instance.
- After removing the product and any included items from the packaging, store, dispose, or recycle the packaging as necessary. Note that certain types of packaging may be a suffocation or choking hazard.

#### Graphical symbols for use on equipment and their descriptions

Symbol	Explanation
	Alternating current (A.C.)
	Direct current (D.C.)
	Protective earth
	Protective bonding earth
	Functional earth
	For indoor use only
	Class II equipment (equipment in which protection against electric shock relies on Double Insulation or Reinforced Insulation)
	"ON" (power)
	"OFF" (power)
	Stand-by (power)
	"ON"/"OFF" (power; push-push)
	Caution, risk of electric shock

### Disposal of Old Equipment (Only for European Union and countries with recycling systems)



This symbol (①) on the products, packaging, and/or accompanying documents means that used electrical and electronic products must not be mixed with general household waste. For proper treatment, recovery and recycling of old products, please take them to applicable collection points in accordance with your national legislation.

By disposing of them correctly, you will help to save valuable resources and prevent any potential negative effects on human health and the environment.

For more information about collection and recycling, please contact your local municipality. Penalties may be applicable for incorrect disposal of this waste, in accordance with national legislation.

#### For business users in the European Union

If you wish to discard electrical and electronic equipment, please contact your dealer or supplier for further information.

#### Information on Disposal in other Countries outside the European Union

This symbol (①) is only valid in the European Union. If you wish to discard this product, please contact your local authorities or dealer and ask for the correct method of disposal.

## 2.9 For India only

### Declaration of Conformity with the requirements of the E-Waste (Management) Rules

The Product is in conformity with the requirements of the reduction of hazardous substances of the E-Waste Rules.

The content of hazardous substance with the exemption of the applications listed in SCHEDULE II of the E-Waste Rules:

1. Lead (Pb) – not over 0.1% by weight;
2. Cadmium (Cd) – not over 0.01% by weight;
3. Mercury (Hg) – not over 0.1% by weight;
4. Hexavalent chromium (Cr6+) – not over 0.1% by weight;
5. Polybrominated biphenyls (PBBs) – not over 0.1% by weight;
6. Polybrominated diphenyl ethers (PBDEs) – not over 0.1% by weight.

### Disposal information



For the purpose of recycling to facilitate effective utilization of resources, please return this product to a nearby authorized collection centre, registered dismantler or recycler, or Panasonic service centre when disposing of this product.

Please see the Panasonic website for further information on collection centres, etc., or call the toll-free number below.

Website:

<http://www.panasonic.com/in/corporate/sustainability/panasonic-india-i-recycle-program.html>

Service helpline: 1800 103 1333 or 1800 108 1333

## 2.10 For Europe

### Contact to Authorised Representative:

Panasonic Testing Centre

Panasonic Marketing Europe GmbH

Winsbergring 15, 22525 Hamburg, Germany

### Ecodesign information

Ecodesign information under EU Regulation (EC) No. 1275/2008 amended by (EU) Regulation No. 801/2013. From 1 January 2015.

Please visit here: <http://www.ptc.panasonic.eu/erp>  
Click [Downloads] → [Energy related products information (Public)]

Power consumption in networked standby and guidance are mentioned in the web site above.

This device is classified as a HiNA device (networked equipment with high network availability), according to Ecodesign requirements.

### 3. Preparation

## 3.1 Device diagrams

#### Front view



#### Rear view

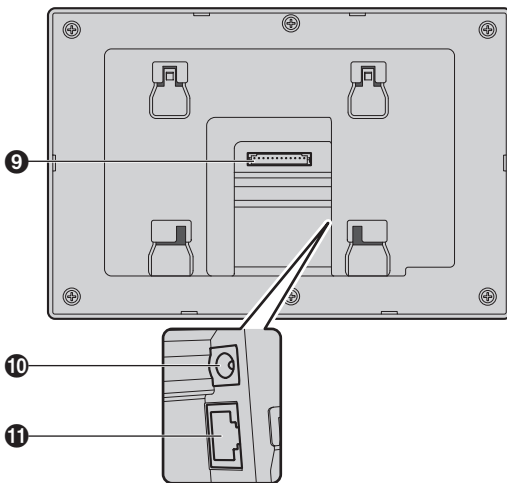

This button flashes on the "main" room monitor when there are new text messages, voice messages, video messages, or missed calls. It does not flash on a "sub" room monitor.

#### 9 Terminal connector

Used to connect external devices (user supplied) to the room monitor.

#### 10 DC IN connector

Used to connect the room monitor to a power supply unit (sold separately) when no PoE power supply is available.

#### 11 LAN connector

Used to connect the room monitor to the network.

#### 1 Display

The display turns on automatically when there is activity, such as when you are receiving a call. You can also turn the display on manually by tapping it when it is off.

The display turns off after a while if there is no activity.

#### 2 Speaker

#### 3 Microphone

#### 4 Call centre button (☎)

Allows you to call an on-site phone, such as the facility staff office, common area phone, etc.

#### 5 Home button (☰)

Displays the home screen.

#### 6 Talk button (🗨)

Allows you to answer the current call or start talking while monitoring.

#### 7 Monitor button (📹)

Allows you to monitor images from a camera.

#### 8 Play button (▶)

Allows you to display messages and missed calls.



## 3.2 Home screen

You can display the home screen by tapping the display when the display is turned off, and by tapping ☰ when the display is on.

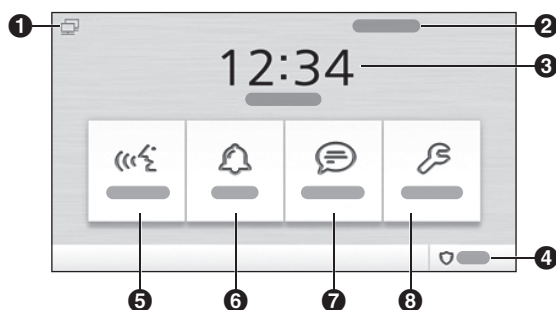

### 1 Status bar



Displays icons that indicate the room monitor's status (see 3.4 Status icons (Page 10)).

### 2 Room number

### 3 Date and time

### 4 Arm mode icon

Indicates the current arm mode and allows you to change the arm mode.

-  Alarm features are armed.
-  Alarm features are disarmed.

### 5 "Talk" feature button\*<sup>1</sup>

Used to make calls, monitor a camera, view missed calls, etc.

### 6 "Alarm" feature button\*<sup>1</sup>

Used to access alarm features, such as viewing status, alarm logs, etc.

### 7 "Message" feature button\*<sup>1</sup>

Used to access playback and message features such as viewing recordings and pictures, checking messages, etc.

### 8 "Settings" feature button

Used to change the room monitor's settings.

\*1 Number icons (1–5, ...) are displayed when there is new information (missed calls, new messages, etc.) to be displayed on the corresponding screen. The number icon indicates the number of new items; when there are 6 or more new items, ... is displayed. These icons are displayed on the "main" room monitor only. They are not displayed on a "sub" room monitor.

#### Clearing the number icons

"Talk" feature button: Tap "Talk". The number icon disappears once the call log is displayed.

"Alarm" and "Message" feature buttons: Tap the corresponding feature button. Once you have tapped each new item in the alarm log or message list, the number icon disappears.

### 3.3 Feature screens

Tapping a feature button in the home screen displays the corresponding feature screen.

Layout and available features vary depending on the screen; the following description applies to most screens.

**Example: "Talk" screen**

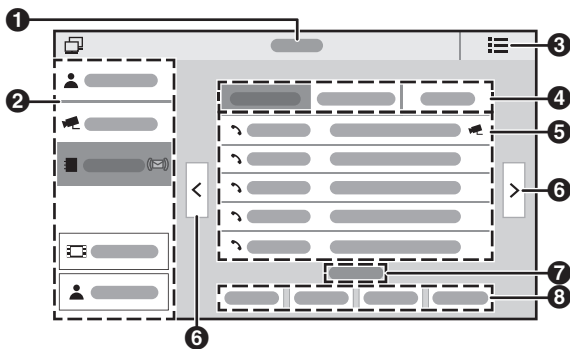

**1 Screen title**

**2 Menu**

Allows you to select the desired feature or information. The currently selected item is highlighted.

**3 Home button**

Displays the home screen.

**4 Tabs**

Allow you to select the type of information that is displayed. The currently selected item is highlighted.

**5 Information area**

Allow you to select a specific item.

**6 Navigation buttons**

Displayed when there are multiple pages of items. Tap "<" to display the previous page, and ">" display the next page.

**7 Page indicators**





Displayed when there are multiple pages of items. The current page is highlighted.

**8 Operation buttons**





Allow you to perform various operations.

### 3.4 Status icons

#### Status bar icons

-  Indicates the room monitor is connected to the network.
-  Indicates the room monitor is not connected to the network. Contact facility staff.
-  Indicates that the room monitor cannot make or receive calls. Contact facility staff.
-  Indicates the room monitor is in "do not disturb" mode. See 8.1 Changing the room monitor's settings (Page 23).
-  Indicates the room monitor's memory is full. Delete unneeded data, such as unneeded video or pictures.

#### Other status icons

-  **Camera images screen**  
Displayed in the upper-right corner when camera images are being recorded.
- \*1 **"Talk", "Message", "Alarm" screens**  
Displayed when there is new information to be displayed.
-  **"Talk" screen**  
Displayed next to new items in the call log.
- \*1 **"Talk" screen**  
Displayed next to new items in the call log for which video messages have been recorded.
-  **"Alarm", "Message" screens**  
Displayed next to new items in the alarm log and message list.

- \*1 **"Talk" and "Message" screens**  
These icons are displayed on the "main" room monitor only. They are not displayed on a "sub" room monitor.
- "Alarm" screen**  
This icon is displayed on the room monitor that is connected to the device that was triggered.

### 3.5 Main vs. sub room monitors

---

If there are multiple room monitors installed in the residence, one room monitor is the "main" room monitor and the others are "sub" room monitors. This is determined at the time of system configuration and cannot be changed by residents.

Certain status icons and notifications are displayed on the main room monitor only.

## 4. Talking and monitoring features

### 4.1 Difference between talking and monitoring

"Talking" means that 2 parties can talk to and hear each other. If one party (for example, a visitor) calls and the other party (for example, a resident) answers, the 2 parties can talk. While talking, you (the room monitor user) will be able to see the camera image of the person you are talking to, if available. When you are using a room monitor to talk, the other party cannot see you.

"Monitoring" means that a resident is using a room monitor to view live camera images from a lobby station, door station, or standalone camera installed in the facility. While monitoring, you can see what is happening at the camera, but no sound is heard.

### 4.2 Answering calls

When you receive a call, the room monitor rings. If the other party is using a device with a camera (such as a lobby station), the camera image is also displayed.

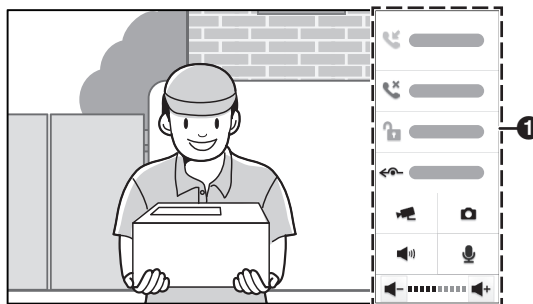

#### 1 Available features

##### Answering a call

1. Tap **"Answer"** or press [☎].
  - Speak within about 50 cm of the microphone.
  - Speak alternatively with the other party. If you and the other party speak at the same time, you will not hear each other.
  - Calls are disconnected after the pre-programmed "timeout" time elapses.
2. When finished, tap **"Hang Up"** or press [☎].
  - If the display turns off while talking, you can turn it on again by tapping the display.

##### Features available while talking on a call

- **"Hang Up"**: Ends the call.
- **"Unlock"**: Opens the corresponding door.
- **"Forward"**: See 4.4 Transferring calls (Page 14).
- 📹: Records camera images and saves them in your room monitor as a video file. (Sound from the room monitor's microphone is not recorded.)
- 🛑: Stop recording.
- 📷: Captures a still image (i.e., picture) from the camera and saves it in your room monitor.
- 🔊: Indicates the room monitor's speaker is on. Tap to turn the speaker off (i.e., mute the other party's voice).
- 🔇: Indicates the room monitor's speaker is off. Tap to turn the speaker on (i.e., turn off the mute).
- 🗣️: Indicates the room monitor's microphone is on. Tap to turn the microphone off (i.e., mute your voice).
- 🗣️: Indicates the room monitor's microphone is off. Tap to turn the microphone on (i.e., turn off the mute).
- 🔊: Decreases the room monitor's speaker volume.
- 🔊+: Increases the room monitor's speaker volume.

### Note:

- Certain features may not be available depending on system configuration, the type of device being used by the other party, etc.

---

### 4.3 Making calls

You can call other residences, common area phones or the facility staff office, and even other rooms in your own residence.

Once the other party answers, you can use many of the features described in Features available while talking on a call (Page 12).

---

#### Calling another residence

1. From the home screen, tap “**Talk**”.
2. Tap “**Call**” on the left side of the screen.
3. Use the on-screen keypad to enter the desired room number, and then tap .

---

#### Calling a common area phone or the facility staff office

1. From the home screen, tap “**Talk**”.
2. Tap “**Call Centre**” on the left side of the screen.
  - A list of available items is displayed.
  - You can skip the previous steps by pressing .
3. Select the desired item.
4. Tap “**Call**”.

---

#### Calling another room in your residence

If you have room monitors installed in different rooms in your residence, you can call those rooms and use the system as an intercom. Each room monitor has an extension number (0–4).

1. From the home screen, tap “**Talk**”.
2. Tap “**Call**” on the left side of the screen.
3. Use the on-screen keypad to enter “**#**” and the extension number (0–4), and then tap .

---

#### Calling by using the phonebook

For information about adding items to the phonebook, see 7.2 Adding entries (Page 22).

1. From the home screen, tap “**Talk**”.
2. Tap “**Call**” on the left side of the screen.
3. Tap  in the on-screen keypad.
  - A list of available items is displayed.
4. Select the desired item.
5. Tap “**Call**”.

### 4.4 Transferring calls

While talking on a call, you can transfer the call to another room monitor within your residence or to another residence.

- 1 While talking on a call, tap **“Forward”**.
- 2 **Transferring within your residence**  
Enter **“#”** and the extension number (0–4), tap outside of the on-screen keypad to close it, and then tap **“OK”**.
  - Your room monitor calls the other room monitor.**Transferring to another residence**  
Enter the room number, tap outside of the on-screen keypad to close it, and then tap **“OK”**.
  - Your room monitor calls the other residence.
- 3 Perform one of the following.
  - Tap **“Return”** to return to the original call.
  - Tap **“Hang Up”** after the other person answers. The other person will be connected to the call, and your room monitor will be disconnected automatically.

---

#### Answering a transferred call

When another room monitor user transfers a call to your room monitor, tap **“Answer”** to talk to the other room monitor user. When the other user hangs up, you will be connected to the call.

### 4.5 Monitoring camera images

You can monitor live camera images from lobby stations, your own door stations, and other cameras installed in the facility. While monitoring, you can see what is happening at the camera, but no sound is heard.

- 1 From the home screen, tap **“Talk”**.
- 2 Tap **“Monitor”** on the left side of the screen.
- 3 Select the desired tab.
  - **“Lobby/Door”**: Allows you to select a lobby station or door station camera.
  - **“IP Camera”**: Allows you to select a standalone camera installed elsewhere in the facility.
- 4 Select the desired camera.
- 5 When finished, tap **☰**.

---

#### Calling the camera while monitoring

While monitoring a lobby station or door station, you can call and talk to a visitor. To call, press **[☎]**.

---

#### Features available while monitoring camera images

- **“Previous”**: Displays the image from the previous camera in the list.
- **“Next”**: Displays the image from the next camera in the list.
- **“Record”**<sup>\*1</sup>: Records camera images and saves them in your room monitor as a video file. When recording, press **“Stop”** to stop recording.
- **“Snapshot”**<sup>\*1</sup>: Captures a still image (i.e., picture) from the camera and saves it in your room monitor.
- **“Return”**: Cancels monitoring.
- **“Call Centre”**: Allows you to call a common area phone or the facility staff office.



#### Note:

- Certain features may not be available depending on system configuration.
  - **“Unlock”** is not available when monitoring camera images.
- <sup>\*1</sup> Not available when monitoring a standalone camera (IP camera).

---

## 4.6 Viewing call log

The room monitor logs information about calls you have answered, missed, and made, and saves it in the call log. Follow this procedure to view the call log.

- 1 From the home screen, tap **“Talk”**.
- 2 Tap **“Call Log”** on the left side of the screen.
- 3 Select the desired tab.
  - **“Missed”**: Displays calls you received but did not answer.
  - **“Answered”**: Displays calls you answered.
  - **“Called”**: Displays calls you made.
- 4 Browse the call log as needed.
  -  is displayed next to each new item, and disappears when you tap the item or when you exit this screen.
- 5 When finished, tap .

---

### Viewing video messages

If a visitor calls you from a lobby station and recorded a video message for you, you can play the video by tapping  next to the missed call information.

#### Note:

- This feature may not be available depending on system configuration.
- See 5.3 Controlling video playback (Page 17) for information about controlling video playback.

---

### Features available while viewing the call log

- **“Call”**: Calls the selected item.
- **“Save”**: Saves the selected item in the phonebook.
- **“Delete”**: Deletes the selected item.
- **“Delete All”**: Deletes all items in the selected tab.

---

### Limitations

250 items of each call type can be saved. Subsequent items will overwrite the oldest items.

## 5. Playback and messaging features

---

---

### 5.1 Playing video messages from visitors

Visitors who call you from a lobby station can leave you a video message if you do not answer.

Follow this procedure to play your video messages.

- 1 From the home screen, tap **“Message”**.
- 2 Tap **“Guest Msg.”** on the left side of the screen.
- 3 Select the desired message and then tap **“View”**.
- 4 When finished, press **[☰]**.

**Note:**

- This feature may not be available depending on system configuration.

---

#### Controlling video playback

See 5.3 Controlling video playback (Page 17).

---

#### Features available while viewing the video message list

- **“View”**: Displays the selected item.
- **“Delete”**: Deletes the selected item.
- **“Delete All”**: Deletes all items.

---

#### Limitations

Up to 50 video messages can be saved, depending on total memory available. Subsequent videos will overwrite the oldest items.

---

### 5.2 Playing videos you recorded

You can record camera images manually while talking to a visitor or monitoring camera images.

Follow this procedure to play your videos.

- 1 From the home screen, tap **“Message”**.
- 2 Tap **“Video Pictures”** on the left side of the screen.
- 3 Select the **“Videos”** tab.
- 4 Select the desired video and then tap **“View”**.
  - Sound from the room monitor’s microphone is not recorded, so it is not heard when playing videos.
- 5 When finished, press **[☰]**.

---

#### Controlling video playback

See 5.3 Controlling video playback (Page 17).

---

#### Features available while viewing the video list

- **“View”**: Displays the selected item.
- **“Delete”**: Deletes the selected item.
- **“Delete All”**: Deletes all items.

---

#### Limitations











Up to 50 videos can be saved, depending on total memory available. Subsequent videos will overwrite the oldest items.



---

### 5.3 Controlling video playback

The following controls are available by tapping the screen while playing a video.

-  Pauses video playback.
-  Resumes video playback.
-  Stops video playback.
-  Fast-forwards playback.
-  Slows the playback speed.
-  Plays the next video.
-  Plays the previous video.
-  Decreases the speaker volume.
-  Increases the speaker volume.
-  Displays the previous screen.

---

### 5.4 Viewing pictures

When a visitor calls you from a lobby station or door station, a picture can be captured automatically. You can also capture pictures manually while talking to a visitor or monitoring camera images.

Follow this procedure to view pictures of your visitors.

- 1 From the home screen, tap **“Message”**.
- 2 Tap **“Video Pictures”** on the left side of the screen.
- 3 Select the **“Pictures”** tab.
- 4 Select the desired picture and then tap **“view”**.
- 5 When finished, press **[≡]**.



#### Note:

- Visitor pictures are captured automatically by default. This feature is determined by the **“Auto Snapshot”** setting (8.1 Changing the room monitor’s settings (Page 23)).

---

#### Controlling picture playback

The following controls are available when viewing pictures.

-  Displays the previous picture.
-  Plays the next picture.
-  Displays the previous screen.

---

#### Features available while viewing the picture list

- **“view”**: Displays the selected item.
- **“Delete”**: Deletes the selected item.
- **“Delete All”**: Deletes all items.

---

#### Limitations

Up to 100 pictures can be saved. Subsequent pictures will overwrite the oldest items.



## 5. Playback and messaging features

---

### 5.5 Viewing text messages from facility staff

Facility staff can send text messages to room monitors throughout the facility. If you receive a message from facility staff,  on the main room monitor will flash until you have confirmed the message.

Follow this procedure to view your text messages.

- 1 From the home screen, tap **“Message”**.
- 2 Tap **“Text Msg.”** on the left side of the screen.
  - You can skip the previous steps by pressing .
  - If **“Text Msg.”** is not displayed, the system does not support text messages.
- 3 Select the desired message and then tap **“View”**.
  - To display other messages, tap **“OK”** and then repeat this step.
- 4 When finished, press .

#### Note:

- This feature may not be available depending on system configuration.

---

#### Features available while viewing the text message list

- **“View”**: Displays the selected item.
- **“Delete”**: Deletes the selected item.
- **“Delete All”**: Deletes all items.

---

#### Limitations

Up to 250 text messages can be saved. Subsequent text messages will overwrite the oldest items.

### 5.6 Playing voice messages from facility staff

Facility staff can send voice messages to room monitors throughout the facility. If you receive a message from facility staff,  on the main room monitor will flash until you have confirmed the message.

Follow this procedure to play your voice messages.





- 1 From the home screen, tap **“Message”**.
- 2 Tap **“Voice Mail”** on the left side of the screen.
  - You can skip the previous steps by pressing .
  - If **“Voice Mail”** is not displayed, the system does not support voice messages.
- 3 Tap **“Play”**.
- 4 After the message is played, follow the voice guidance and tap **“1”**, **“2”**, or **“3”** to perform other operations.
- 5 When finished, tap **“Hang Up”**.

#### Note:

- This feature may not be available depending on system configuration.

---

#### Features available while playing voice messages

- **“Hang Up”**: Stops playback and returns to the previous screen.
-  : Indicates the room monitor’s speaker is on. Tap to turn the speaker off.
-  : Indicates the room monitor’s speaker is off. Tap to turn the speaker on.
-  : Decreases the room monitor’s speaker volume.
- + : Increases the room monitor’s speaker volume.

---

#### Limitations

Voice messages are deleted automatically after 30 days. Make sure you listen to your voice messages in a timely manner.

## 6.1 Alarm features overview

### Devices and notifications

Commercially available push buttons and sensors can be connected to the room monitor, such as a doorbell, emergency button, gas leak sensor, water leak sensor, etc. When one of these devices is triggered, the room monitor responds accordingly. For example, if a doorbell is pressed, the room monitor sounds a chime and displays a notification; if a gas leak sensor is triggered, the room monitor sounds an alarm, displays a notification, and also notifies facility staff.

### Alarm features 1–6

Up to 6 devices can be connected to the room monitor. Each device is used to trigger the corresponding alarm feature.

- Device 1: Urgency button, triggers alarm feature 1.
- Device 2: Emergency button, triggers alarm feature 2.
- Device 3: Doorbell, triggers alarm feature 3.
- Devices 4–6: Triggers alarm features 4–6. Set the “**Device Type**” setting to match the type of device that is connected (6.4 Changing alarm feature settings (Page 20)).

### Arm modes

Alarm features are enabled or disabled based on the current arm mode. There are 4 different arm modes, and you can determine which alarm features are enabled for each. In order to enable or disable different alarm features during different times of the day, you can change the arm mode before you leave your residence, when you come home, before you go to bed, etc. You can also disarm (disable) the room monitor’s alarm features.

## 6.2 Changing the arm mode

### Arming the system

1. From the home screen, tap the current arm mode (displayed in the lower-right corner of the display).
2. Select the desired arm mode.
  - “**Out**”: This arm mode is suggested for use when no one is home.
  - “**At Home**”: This arm mode is suggested for use when you are home, but want to keep some alarm features enabled.
  - “**Sleep**”: This arm mode is suggested for use when you are home and sleeping.
  - “**Custom**”: This arm mode has no particular suggested use.
3. Enter the arm/disarm password, tap outside of the on-screen keypad to close it, and then tap “**OK**”.
  - The arm mode is changed, and your alarm features are enabled or disabled according to their settings for the current arm mode.
  - The default arm/disarm password is “123456”.
  - This password is determined by the “**Arm/Disarm PW**” setting (8.1 Changing the room monitor’s settings (Page 23)). We recommend changing this and all passwords regularly.

### Disarming the system

1. From the home screen, tap the current arm mode (displayed in the lower-right corner of the display).
2. Enter the arm/disarm password, tap outside of the on-screen keypad to close it, and then tap “**OK**”.
  - “**Arm: Off**” is selected and all alarm features are disabled.
  - The default arm/disarm password is “123456”.
  - This password is determined by the “**Arm/Disarm PW**” setting (8.1 Changing the room monitor’s settings (Page 23)). We recommend changing this and all passwords regularly.

---

### 6.3 Configuring each arm mode

You can select which alarm features are enabled and disabled for each arm mode.

- 1 From the home screen, tap **“Alarm”**.
- 2 Tap **“Mode Settings”** on the left side of the screen.
- 3 Enter the user password and then tap **“OK”**.
  - The default user password is "123456".
  - This password is determined by the **“User PW”** setting (8.1 Changing the room monitor’s settings (Page 23)). We recommend changing this and all passwords regularly.
- 4 Select the tab that corresponds to the arm mode you want to edit.
- 5 Tap each alarm feature (**“Alarm 1”**–**“Alarm 6”**) to turn them on or off for the selected arm mode.
- 6 When finished, tap **☰**.

---

### 6.4 Changing alarm feature settings

- 1 From the home screen, tap **“Alarm”**.
- 2 Tap **“Alarm Status”** on the left side of the screen.
- 3 Select the desired alarm feature and then tap **“Set”**.
  - To quickly remove or bypass an alarm feature, tap **“off”** or **“Off (Once)”** instead of **“Set”**.
- 4 Enter the user password and then tap **“OK”**.
  - The default user password is "123456".
  - This password is determined by the **“User PW”** setting (8.1 Changing the room monitor’s settings (Page 23)). We recommend changing this and all passwords regularly.
- 5 Select the desired field, change the setting as desired, and then tap **“OK”**.
  - For details about each setting, see Alarm feature settings (Page 20).
- 6 When finished, tap **☰**.

---

#### Alarm feature settings

- **“Alarm No.”**: Indicates the alarm feature number. Cannot be changed.
- **“Device Type”**: Allows you to set the type of device that is connected. This setting affects the way notifications are displayed when this device is triggered. This setting cannot be changed for **“Alarm 1”**–**“Alarm 3”**.
- **“NO/NC”**: This setting should match the specifications of the device. Select **“NO”** if the device is normally open; select **“NC”** if the device is normally closed.
- **“Timing”**: Determines how quickly the device’s detection is acted upon. The following settings are available.
  - **“No-delay Alarm”**: The notification will be sent as soon as the device is triggered.
  - **“Delay Alarm”**: There will be a delay before the alarm feature is enabled or before the notification is sent. Select this setting if you want to use **“Entry Delay”** or **“Exit Delay”**.
  - **“Off”** (available only when alarm features are disabled): The alarm feature is disabled.
  - **“Off (Once)”** (available only when alarm features are disabled): The next time the alarm features are armed, the alarm feature will be disabled. After the alarm features are disarmed and armed again, the setting returns to its previous setting.
- **“Entry Delay”**: When the arm mode is **“Out”**, the entry delay can give you time to change the arm mode when you return home. Available only when **“Timing”** is set to **“Delay Alarm”**.

- **“Exit Delay”**: When you set the arm mode to **“Out”**, the exit delay can give you time to leave the house before the alarm features are enabled. Available only when **“Timing”** is set to **“Delay Alarm”**.

---

## 6.5 Confirming alarm feature status and settings

- 1 From the home screen, tap **“Alarm”**.
- 2 Tap **“Alarm Status”** on the left side of the screen.
  - The status and settings for each alarm feature are displayed.
- 3 When finished, tap **☰**.

---

## 6.6 Viewing the alarm log

The room monitor logs information when alarm features are triggered and saves it in the alarm log. Follow this procedure to view the alarm log.

- 1 From the home screen, tap **“Alarm”**.
- 2 Tap **“Alarm Log”** on the left side of the screen.
- 3 Browse the alarm log as needed.
  -  is displayed next to each new item, and disappears when you tap the item.
- 4 When finished, tap **☰**.

### Note:

- Door bell and urgency button events are not saved in the alarm log.

---

### Features available while viewing the alarm log

- **“Delete”**: Deletes the selected item.
- **“Delete All”**: Deletes all items.

---

### Limitations

250 items can be saved in the alarm log. Subsequent items will overwrite the oldest items.

## 7. Phonebook features



---

---

### 7.1 Viewing the phonebook

You can add the rooms you call frequently to the room monitor's phonebook for easy calling.

Follow this procedure to view your phonebook.

- 1 From the home screen, tap **Talk**.
- 2 Tap **Call** on the left side of the screen.
- 3 Tap  in the on-screen keypad.
  - A list of available items is displayed.
- 4 Browse the phonebook as needed.
  - To perform an operation for a specific item, tap the item.
- 5 When finished, tap .

---

#### Features available while viewing the phonebook

- **Call**: Calls the selected item.
- **Add**: Allows you to add a new item to the phonebook.
- **Edit**: Allows you to edit the selected item.
- **Delete**: Deletes the selected item.
- **Delete All**: Deletes all items in the phonebook.



---

#### Limitations

162 items can be saved in the phonebook. To save more items, you must first delete existing items.

---

### 7.2 Adding entries

- 1 From the home screen, tap **Talk**.
- 2 Tap **Call** on the left side of the screen.
- 3 Tap  in the on-screen keypad.
- 4 Tap an empty memory location, or tap **Add**.
- 5 Tap the desired field (first name, last name, or room number) and enter the desired party's information.
  - Up to 6 characters can be entered for the first name and last name.
  - After entering information, tap outside of the on-screen keyboard or keypad to close it.
- 6 Tap **Save** to save the information.
  - To add a room monitor installed in another room in your residence, enter **#** and the extension number (0–4) as the room number.
- 7 When finished, tap .

## 8.1 Changing the room monitor's settings

- 1 From the home screen, tap "Settings".
  - A list of available setting categories is displayed.
- 2 Select "User Settings" on the left side of the screen.
  - "Administrator" are administrator-level settings and are not explained in this document. An administrator password must be entered in order to view or change these settings.
- 3 Select the desired setting category.
- 4 Change the settings as desired.
- 5 Tap "OK" to save the new settings.
- 6 When finished, tap ☰.

## 8.2 List of settings

Category	Settings	Description
Password <sup>*1</sup>	User PW	Password that is required in order to change basic settings.
	Unlock PW <sup>*2</sup>	Password that is required in order to open the door while using the lobby station. This password has no default setting. The first time you try to change this password, leave the "old" password field blank.
	Arm/Disarm PW	Password that is required in order to change the arm mode.
	Anti-hijack PW	If an intruder forces you to disarm the room monitor's alarm features, you can discreetly notify facility staff by entering the anti-hijack password instead of the disarm password. The default password is "654321". For more information about this feature, contact facility staff.
Display	Brightness	Determines the display's brightness.
	Screensaver Time	Determines the amount of time that passes before the display turns off when there is no activity.
	Language	Determines the language used for the room monitor's screens.
Sound	Door Phone Ring	Determines the ringtone heard when you receive a call.
	Ring Volume	Determines the ringtone volume.
	Alarm Sound	Determines the tone heard when an alarm feature is triggered.
	Alarm Volume	Determines the alarm tone volume.
	Speaker Volume	Determines the speaker volume.
Talk	Monitor Time	Determines the maximum amount of time you can monitor camera images.
	Record Time	Determines the maximum amount of time you can record camera images.
DND	Do Not Disturb Time	Allows you to set an amount of time during which the room monitor will not ring, even if someone calls you.

## 8. Room monitor settings

---

Category	Settings	Description
Memory	—	Displays the amount of space used/available in the room monitor's memory.
	Format	Allows you to delete all content in the room monitor's memory. The user password is required in order to use this feature.
Cleaning	—	Allows you to disable the display temporarily, such as for cleaning. When finished, press <b>[▶≡]</b> to turn the display on again.
Default	—	Allows you to reset all room monitor settings to their default values. The user password is required in order to use this feature.
Touch Sound	—	Determines whether a confirmation sound is heard when you tap the room monitor's screen or press its buttons.
Auto Snapshot	—	Determines whether a picture is captured automatically when someone calls you from a lobby station or door station.

\*1 We recommend changing all passwords regularly.

\*2 This item cannot be changed when using a sub room monitors. See 3.5 Main vs. sub room monitors (Page 11).



## 9.1 Lobby station overview

This section briefly explains how to operate commonly used features of the lobby station.

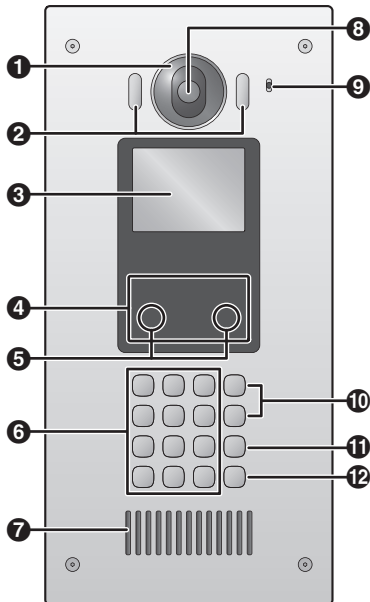

- 1 Lens cover**
- 2 Light**  
Illuminates subjects in dark environments.
- 3 Display**
- 4 Card reader**  
Allows the door to be unlocked by using a card. The lobby station beeps if the card cannot unlock the door.
- 5 Motion sensor**  
Turns on the display when a visitor is detected.
- 6 Keypad**
- 7 Speaker**
- 8 Camera lens**
- 9 Microphone**
- 10 Search buttons ([A▲] and [B▼])**  
Used to select items shown on the display.
- 11 Cancel button ([X])**
- 12 Call button ([Δ])**

## 9.2 Lobby station operations

### 9.2.1 Calling a resident

- 1** Enter the resident's room number.
- 2** Press [**Δ**] to call.

### 9.2.2 Calling a receptionist

- 1** Press [**Δ**].
- 2** Press [**A▲**] and [**B▼**] to select the desired item.
- 3** Press [**Δ**] to call.

### 9.2.3 Searching the directory

- 1** Press [**\***].
- 2** Use the keypad to enter the first few letters of the resident's name.
  - Press a key repeatedly to scroll through the letters assigned to that key.
  - Note the hints displayed at the bottom of the screen.
- 3** Press [**A▲**] and [**B▼**] to select the desired item.
- 4** Press [**Δ**] to call.

### 9.2.4 Opening the door by using an access card

Touch your access card to the card reader area of the lobby station (under the display) or to the external card reader (if present).

### 9.2.5 Opening the door by entering an unlock password

- 1** Press [**#**].
- 2** Enter your room number.
- 3** Press [**\***].
- 4** Enter your unlock password.
  - This password is determined by the "UnLock PW" setting (8.1 Changing the room monitor's settings (Page 23)). We recommend changing this and all passwords regularly.
- 5** Press [**#**].

### 9.2.6 Recording a video message

- 1** When the resident does not answer, press [**1**] when prompted to record a video message.
- 2** When finished, press [**X**].

### 10.1 Troubleshooting

#### Camera images (lobby station and door station images)

Problem	Cause & Solution	Page
Images appear distorted.	<ul style="list-style-type: none"> <li>Images may appear distorted because of the characteristics of the camera lens. This is not a malfunction.</li> </ul>	–
The image of the subject is displayed in black and white (or bluish-purple).	<ul style="list-style-type: none"> <li>At night or when there is poor light in the area around the lobby station or door station, the image of the subject may be displayed in black and white (or bluish-purple).                             <ul style="list-style-type: none"> <li>→ The lobby station or door station may need to be configured so that the light turns on when it is dark and a visitor is calling. This setting is available using web programming. For more information, consult your facility staff.</li> </ul> </li> </ul>	–
Images at night are dark and faces cannot be identified.	<ul style="list-style-type: none"> <li>The lobby station's or door station's light is not turning on.                             <ul style="list-style-type: none"> <li>→ The lobby station or door station may need to be configured so that the light turns on when it is dark and a visitor is calling. This setting is available using web programming. For more information, consult your facility staff.</li> </ul> </li> </ul>	–
The images of people's faces are dark.	<ul style="list-style-type: none"> <li>The lobby station's or door station's backlight compensation feature is turned off.                             <ul style="list-style-type: none"> <li>→ The lobby station or door station may need to be configured so that the lobby station's or door station's backlight compensation feature is turned on. This setting is available using web programming. For more information, consult your facility staff.</li> </ul> </li> </ul>	–
Images are dirty or unclear. Images are not in focus.	<ul style="list-style-type: none"> <li>There is dirt on the surface of the lobby station's or door station's lens.                             <ul style="list-style-type: none"> <li>→ Wipe the lens with a soft, dry cloth.</li> </ul> </li> <li>There is water condensation on the surface of the lobby station's or door station's lens.                             <ul style="list-style-type: none"> <li>→ Wait for the condensation to evaporate.</li> </ul> </li> </ul>	– –
Images are white or black.	<ul style="list-style-type: none"> <li>The <b>"Brightness"</b> setting is incorrect.                             <ul style="list-style-type: none"> <li>→ Adjust the setting.</li> </ul> </li> </ul>	23
Images are white, or white lines or circles are shown on the display.	<ul style="list-style-type: none"> <li>Strong light such as sunlight is shining into the lens of the lobby station or door station causing images to be difficult to see on the display. (This is not a malfunction.)                             <ul style="list-style-type: none"> <li>→ Locating the lobby station or door station away from direct sunlight or changing the angle that the lobby station or door station is installed may help reduce this problem.</li> </ul> </li> </ul>	–
There is a small black dot in the background.	<ul style="list-style-type: none"> <li>If the sun can be seen, its centre appears as a black dot. This is not a malfunction.</li> </ul>	–
Images are flickering.	<ul style="list-style-type: none"> <li>AC (alternating current) lights such as fluorescent lights are used near the lobby station or door station.                             <ul style="list-style-type: none"> <li>→ AC (alternating current) lights such as fluorescent lights may cause flickering in dark environments. (This is not a malfunction.)</li> </ul> </li> </ul>	–

#### Sound

Problem	Cause & Solution	Page
The room monitor does not sound a ringtone when a call is received.	<ul style="list-style-type: none"> <li>The <b>"Do Not Disturb Time"</b> setting is activated and the room monitor is in "do not disturb" mode.                             <ul style="list-style-type: none"> <li>→ Adjust the setting.</li> </ul> </li> </ul>	23
	<ul style="list-style-type: none"> <li>The <b>"Ring Volume"</b> setting is incorrect.                             <ul style="list-style-type: none"> <li>→ Adjust the setting.</li> </ul> </li> </ul>	23

## Other

Problem	Cause & Solution	Page
The display does not turn on.	<ul style="list-style-type: none"> <li>● The room monitor is not receiving power.               <ul style="list-style-type: none"> <li>→ When using Power over Ethernet (PoE) Make sure the PoE power supply is turned on and supplying power, then check the LAN cable connection.</li> <li>→ When using a power supply unit Make sure the power supply unit is connected to the AC power supply and is receiving power, then check the AC and DC wiring and the DC plug.</li> </ul> </li> </ul>	31
Calls are disconnected.	<ul style="list-style-type: none"> <li>● An alarm feature was triggered.               <ul style="list-style-type: none"> <li>→ If an alarm feature is triggered (e.g., someone pressed the emergency or urgency button) and notifies facility staff while you are talking, the call is disconnected.</li> </ul> </li> <li>● The current call timed out and was disconnected.               <ul style="list-style-type: none"> <li>→ To conserve system resources, all calls time out and are disconnected after a programmed amount of time.</li> </ul> </li> </ul>	–

## 10.2 Error messages

Display	Cause & Solution	Page
Network error. Call failure.	<ul style="list-style-type: none"> <li>● Consult your facility staff.</li> </ul>	–
Invalid input. Check the room No.	<ul style="list-style-type: none"> <li>● The room number does not exist.               <ul style="list-style-type: none"> <li>→ Confirm the room number and try again.</li> </ul> </li> <li>● You did not enter a room number.               <ul style="list-style-type: none"> <li>→ Confirm the room number and try again.</li> </ul> </li> <li>● The “Call Neighbour” setting has been disabled.               <ul style="list-style-type: none"> <li>→ This setting is available using web programming. For more information, consult your facility staff.</li> </ul> </li> </ul>	–
Invalid. Last name cannot be blank.	<ul style="list-style-type: none"> <li>● You did not enter a last name when saving a phonebook entry.               <ul style="list-style-type: none"> <li>→ Enter both a first and last name.</li> </ul> </li> </ul>	–
The room no. already exists.	<ul style="list-style-type: none"> <li>● You entered a room number that was already saved in the phonebook.               <ul style="list-style-type: none"> <li>→ Confirm the room number and try again.</li> </ul> </li> </ul>	–
Please disarm to change setting.	<ul style="list-style-type: none"> <li>● You tried to change alarm feature settings while the alarm features are armed.               <ul style="list-style-type: none"> <li>→ Disarm the system and try again.</li> </ul> </li> </ul>	19
Cannot disable first three channels!	<ul style="list-style-type: none"> <li>● You tried to change settings for alarm features 1, 2, or 3.               <ul style="list-style-type: none"> <li>→ Settings for alarm features 1, 2, and 3 cannot be changed.</li> </ul> </li> </ul>	–
Invalid password. Check and try again.	<ul style="list-style-type: none"> <li>● You entered the wrong password.               <ul style="list-style-type: none"> <li>→ Confirm the password and try again.</li> </ul> </li> </ul>	–
Failed to change password	<ul style="list-style-type: none"> <li>● You entered the wrong "old" password.               <ul style="list-style-type: none"> <li>→ Confirm the password and try again.</li> </ul> </li> </ul>	–
Password do not match.	<ul style="list-style-type: none"> <li>● When changing a password, you did not enter the new password correctly.               <ul style="list-style-type: none"> <li>→ Confirm the password and try again.</li> </ul> </li> </ul>	–
Lobby Station is not connected	<ul style="list-style-type: none"> <li>● Consult your facility staff.</li> </ul>	–

## 11. Other information

### 11.1 Specifications

#### Room Monitor (VL-MN1000)

<b>Power source</b>	When using PoE: Class 2, IEEE 802.3af When using power supply unit (VL-PS240): 24 V DC, 0.6 A
<b>Power consumption</b>	Standby: approx. 1.9 W for PoE, 2.1 W for VL-PS240 Operating: approx. 6.3 W for PoE, 6.2 W for VL-PS240
<b>Dimensions (mm) (height × width × depth)</b>	Approx. 137.5 × 205 × 27.8 (excluding protruding sections)
<b>Mass (weight)</b>	Approx. 550 g
<b>Operating environment</b>	Ambient temperature: approx. 0 °C to +40 °C Relative humidity (non-condensing): up to 90 %
<b>Display</b>	Approx. 17.7 cm (7-inch) wide-format colour TFT LCD
<b>Installation method</b>	Wall mount (when using included mounting bracket) Flush mount (when using optional VL-VN1790 Flush Mount Box)
<b>Talking method</b>	Hands-free
<b>Video format</b>	H.264 codec
<b>Audio format</b>	G.711 codec
<b>Network interface</b>	Ethernet II (DIX)
<b>Network protocol</b>	TCP/IP, UDP
<b>Communication mode</b>	Speed, Duplex AUTO (10BASE-T/100BASE-TX, FULL/HALF) (Auto negotiation)

#### Power Supply Unit (VL-PS240, sold separately)

The power supply unit is for indoor use only.

<b>Power source</b>	Input: 220-240 V AC, 0.2 A, 50/60 Hz Output: 24 V DC, 0.6 A
<b>Dimensions (mm) (height × width × depth)</b>	Approx. 116 × 100 × 54 (excluding protruding sections)
<b>Mass (weight)</b>	Approx. 230 g
<b>Operating environment</b>	Ambient temperature: approx. 0 °C to +50 °C Relative humidity (non-condensing): up to 90 %
<b>Installation method</b>	Attach to DIN rail Wall mount (using included screws)

---

## 11.2 Cleaning

Wipe the product with a soft, dry cloth.

For excessive dirt, wipe the product with a moist cloth.

**Important:**

- **Do not use any cleaning products that contain alcohol, polish powder, powder soap, benzine, thinner, wax, petroleum, or boiling water. Also do not spray the product with insecticide, glass cleaner, or hair spray. This may cause a change in colour or quality of the product.**

---

### When cleaning the display

Use a soft, dry cloth to clean the display, making sure not to scratch its surface.

**Note:**

- Before cleaning the display, we recommend you use the “**Cleaning**” setting (8.1 Changing the room monitor’s settings (Page 23)) to disable the display temporarily.

---

## 11.3 Open source software notice

Parts of this product use open source software supplied based on the relevant conditions of the Free Software Foundation’s GPL and/or LGPL and other conditions.

Please read all licence information and copyright notices related to the open source software used by this product.

This information is available at the following web page:

<http://panasonic.net/pcc/support/intercom/vn1900>





At least three (3) years from delivery of this product, Panasonic Corporation will give to any third party who contacts us at the contact information provided below, for a charge of no more than the cost of physically distributing source code, a complete machine-readable copy of the corresponding source code and the copyright notices covered under the GPL and the LGPL. Please note that software licensed under the GPL and the LGPL is not under warranty.

<http://panasonic.net/pcc/support/intercom/vn1900>

## 12. Installation

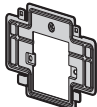
### 12.1 Included items

The following items are included in addition to the room monitor.

Item	Quantity
<b>Mounting bracket</b> 	1
<b>Screw (3.8 mm × 20 mm)</b> Used to secure the room monitor to the mounting bracket. 	3
<b>DC plug</b> Used to connect the power supply unit to the room monitor. 	1
<b>12-pin terminal cable</b> Used to connect devices to the room monitor. 	1

### 12.2 Optional items

The following items are sold separately. Please contact your nearest Panasonic dealer for sales information.

#### Compatible accessories (as of March, 2017)

Item	Model no.
<b>Flush Mount Box</b> Flush mount box for the VL-MN1000 Room Monitor. Allows the room monitor to be installed flush against the wall.	VL-VN1790
<b>Power Supply Unit*1</b> Power supply unit that can be used to power the room monitor when no PoE power supply is available.	VL-PS240

\*1 This product complies with the IEEE 802.3af Power-over-Ethernet (PoE) standard. If PoE is available on your network, this product can receive the necessary power from the network through the Ethernet cable and no power supply unit is needed. If PoE is not available, you will need to connect a power supply unit to the product.

#### Compatible system devices (as of March, 2017)

Item	Model no.
<b>Door Station</b> IP-compatible door station with built-in push button, camera, and card reader. Typically installed immediately outside the residence.	VL-VN1500
<b>Lobby Station</b> IP-compatible lobby station with colour screen, phonebook features, and connection terminals for external electric lock, access controller, etc. Typically installed in a lobby.	VL-VN1900
<b>Control Box</b> Allows the system to accommodate up to 2000 SIP devices.	VL-VN1700

### 12.3 Installation cautions

Refer to the information found in 2 Important information (Page 4) before installing the product.



#### CAUTION

- If the wiring passes outdoors, use a conduit and a surge protector.
- If the wiring passes underground, use a conduit, and do not make any connections underground.
- Install the product securely adhering to the instructions in this document to prevent it from falling off the wall. Avoid installing onto low-strength walls, such as gypsum board, ALC (autoclaved lightweight concrete), concrete block, or veneer (less than 18 mm thick) walls.

### 12.4 Information about power connection

There are 2 methods for powering the room monitor. Choose one or the other; do not use both methods.

- **Using Power over Ethernet (PoE)**  
In this case, the room monitor and a PoE-compatible device (such as a PoE switching hub or a PoE power supply) are connected by a single LAN cable. The LAN cable carries both power and data.
- **Using the VL-PS240 power supply unit (sold separately)**  
In this case, the power supply unit is hardwired to the power source, and connects to the room monitor using the included DC plug.

### 12.5 Power over Ethernet (PoE) connection

To power the room monitor using PoE, use a LAN cable to connect the room monitor and a PoE-compatible device (such as a PoE switch or power supply). See 12.10 Wire and cable specifications (Page 38) for LAN cable specifications.

### 12.6 Installing the power supply unit (sold separately)

If the room monitor will not be powered via PoE, you must install a power supply unit.

#### Required items

- Power supply unit (VL-PS240; sold separately)
- DC plug (included)
- Cable binders (included with power supply unit)
- Screws (included with power supply unit)
- Wires for AC and DC connection (user supplied)  
See 12.10 Wire and cable specifications (Page 38) for specifications.
- Soldering gun and solder, insulation sleeve (user supplied)

#### Installation location

- The device must be installed inside an electrical panel or cabinet.
- A readily accessible disconnect device shall be incorporated external to the equipment.  
The external disconnect device must be certified, and have a creepage and clearance distance of 3 mm or more.

#### Installation methods

The following 2 methods can be used for installing the power supply unit.

- mounting on a DIN rail (user supplied)
- attaching directly to a wall

## 12. Installation

### 12.6.1 Connecting the AC wires, DC wires, and DC plug

- 1 Strip the ends of the wires that connect to the power supply unit as shown below.

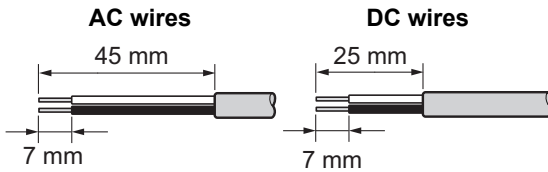

- 2 Remove the cable cover screws and then remove the cable covers.

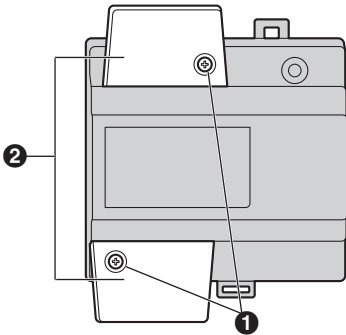

- 1 Screws
- 2 Cable covers

- 3 Connect the AC wires to the AC IN terminals on the top of the power supply unit, and then connect the DC wires to the DC OUT terminals on the bottom of the power supply unit.

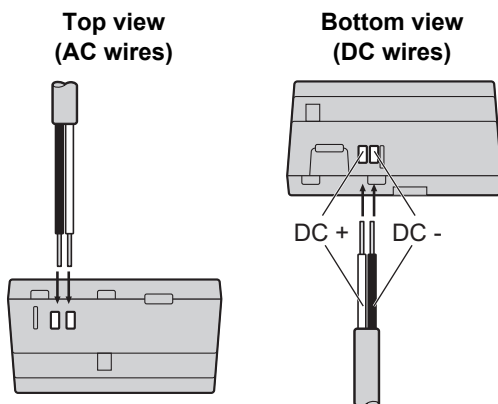

- For DC wires, the black wire is negative (-) and the other colour wire is positive (+). Note the colour of each DC wire and which terminal each

wire should be connected to, and insert the DC wires as shown.



- Insert the power cables firmly all the way into the terminals. If the cables are not inserted all the way, heat may be generated.
- 4 Tighten the terminal screws to secure the AC and DC wires (bare wire area) to the terminals, and then use the cable binders to secure the AC and DC wires (jacketed area) to the cable binder holes on the top and bottom on the power supply unit.

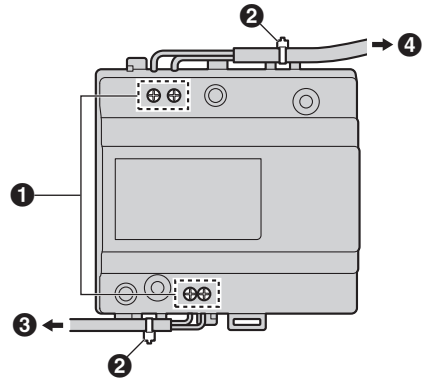

- 1 Terminal screws
- 2 Cable binders connected to cable binder holes
- 3 To room monitor
- 4 To AC power outlet

- Recommended torque:
  - AC IN terminals: 0.5 N·m {5.1 kgf·cm}
  - DC IN terminals: 0.45 N·m {4.6 kgf·cm}

- 5 Strip the remaining ends of the DC wires as shown.

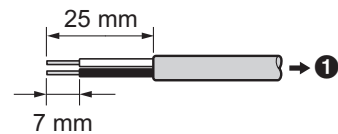

- 1 To DC terminals of power supply unit



- 6 Solder the ends of the DC wires to the DC plug. Use insulation sleeves to insulate the wires.

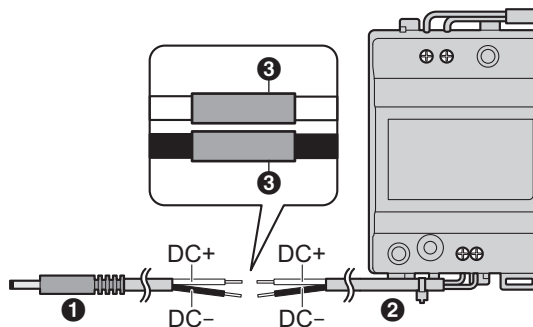

- 1 DC plug
- 2 DC wires
- 3 Insulation sleeve

- 7 Replace the cable covers and then securely fasten the cable cover screws.

### 12.6.2 Mounting on a DIN rail

Attach the power supply unit to the DIN rail so that the bottom hook is positioned at the bottom of the power supply unit.

- 1 Hang the top hooks of the power supply unit on the top of the DIN rail.
  - At this point the power supply unit will be hanging from the DIN rail but will not be secure.
- 2 Pull the lever down, make sure the bottom of the power supply unit is flat against the DIN rail, and then release the lever.
  - The bottom hook will slide up, securing the bottom of the power supply unit to the DIN rail.

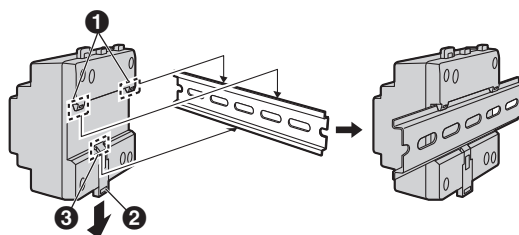

- 1 Top hooks
- 2 Lever
- 3 Bottom hook

### 12.6.3 Attaching directly to a wall

Attach the power supply unit to the wall securely using the 2 mounting screws.

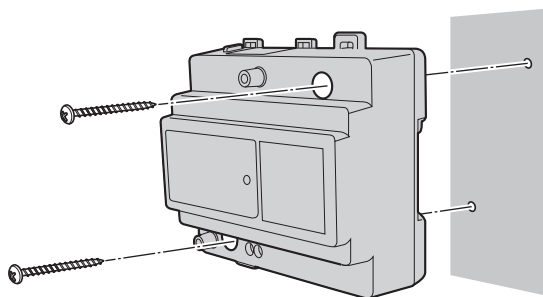

## 12. Installation

### 12.7 Installing the room monitor

#### Required items

- Mounting bracket (included)
- Screws (included)
- LAN cable (user supplied)  
See 12.10 Wire and cable specifications (Page 38) for specifications.

#### Optional items

- Flush mount box (VL-VN1790; sold separately)  
Used to mount the room monitor flush against the wall.
- Screws (included with flush mount box)
- 12-pin terminal cable (included)  
Used to connect external devices to the room monitor.
- External devices (user supplied)
- Wires that connect the external devices to the 12-pin terminal cable (user supplied)  
See 12.10 Wire and cable specifications (Page 38) for specifications.

#### Installation location

- Do not install the product in the following locations. There may be a risk of malfunction or communication disturbances.
  - Places where vibration, impact, or echoing occurs.
  - Places near a high concentration of dust, hydrogen sulphide, ammonia, sulphur, or noxious fumes.
  - Places where there is excessive smoke, dust, and high temperature.
  - Places exposed to direct sunlight.
- Install the product away from electronic appliances such as TVs, radios, personal computers, air conditioners, boiler control panels with intercom, home security equipment, wireless devices, or digital cordless phones.
- Install the room monitor at least 5 m away from the door station.
- Install the room monitor so that the centre of the display is at eye level.

- To prevent malfunction and sound cutting out, leave at least 20 cm of space above, below, and on the sides of the room monitor.

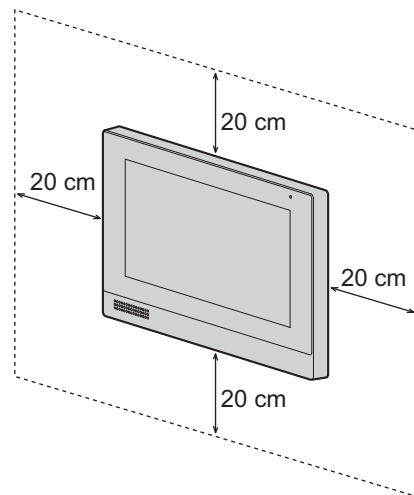

- Install the room monitor (including the mounting bracket or the flush mount box) on a flat, vertical wall.

### 12.7.1 Installing by using mounting bracket

- 1 Determine the installation location of the room monitor (Installation location (Page 34)).
- 2 Determine the installation location of the mounting bracket.

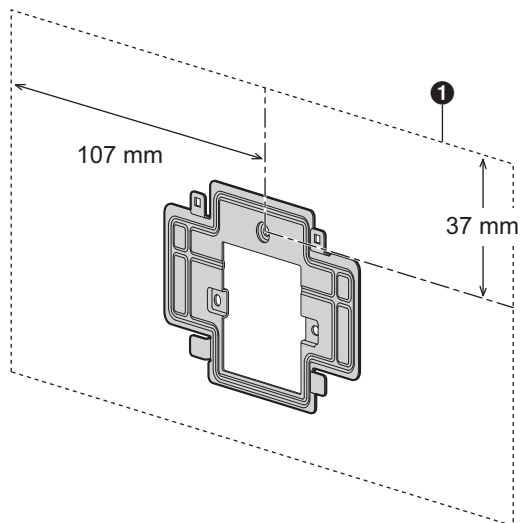

- 1 Room monitor installation location

- 3 Open a hole in the wall for the wires and cables, and then attach the mounting bracket to the wall using the mounting screws.

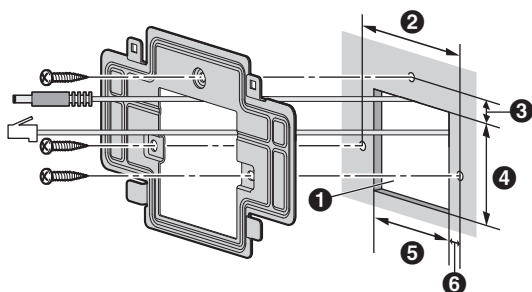

- 1 Hole in wall  
 2 72 mm  
 3 13 mm  
 4 58 mm  
 5 50 mm  
 6 11 mm

- 4 Connect the wires and cables to the room monitor.
  - See 12.7.3 Connecting the wires and cables (Page 37).

- 5 Attach the room monitor to the mounting bracket by first lining up the tab on the bottom of the bracket with the groove on the room monitor.

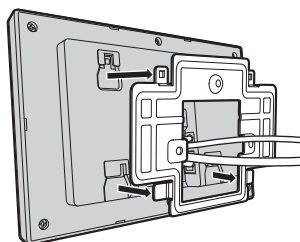

- 6 Line up the tab on the top of the mounting bracket with the groove on the room monitor, and push the room monitor down until it is secure.

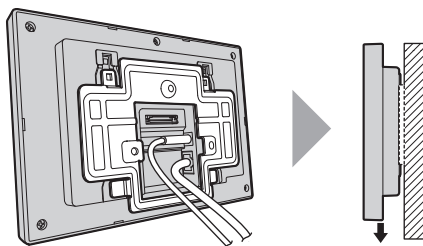

## 12. Installation

### 12.7.2 Installing by using the flush mount box (sold separately)

- 1 Open a hole in the wall for the flush mount box.
  - Note the dimensions of the flush mount box.

Front view

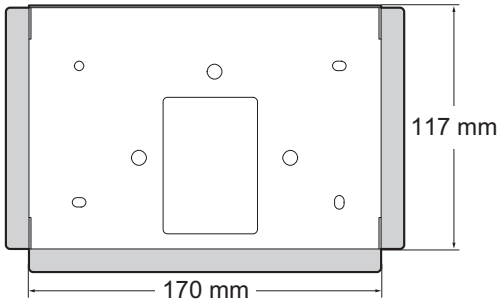

Side view

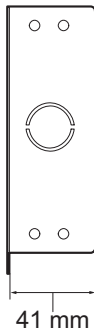

- 2 Open the knockout holes of the flush mount box, and then pass all necessary wires and cables (DC plug, LAN cable, 12-pin terminal cable) through the knockout holes.

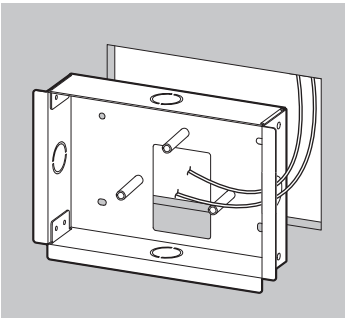

- 3 Install the flush mount box in the wall and attach the mounting bracket to the flush mount box using the 3 mounting screws.

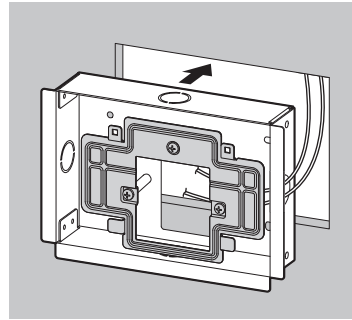

- 4 Connect all necessary wires and cables to the room monitor.
  - See 12.7.3 Connecting the wires and cables (Page 37).
- 5 Attach the room monitor to the flush mount box, and push the room monitor down until it is secure.

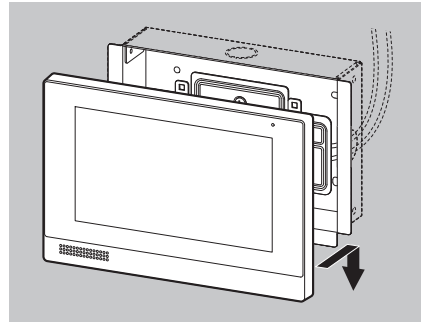

### 12.7.3 Connecting the wires and cables

1 Connect the LAN cable to the LAN connector.

#### 2 Optional

If you are using a power supply unit to power the room monitor, connect the DC plug to the DC IN connector.

- See 12.6 Installing the power supply unit (sold separately) (Page 31) for information about installing the power supply unit.

#### 3 Optional

If you are connecting external devices, connect the 12-pin terminal cable to the terminal connector.

- See 12.8 Connecting external devices (Page 37) for information about connecting external devices to the 12-pin terminal cable.

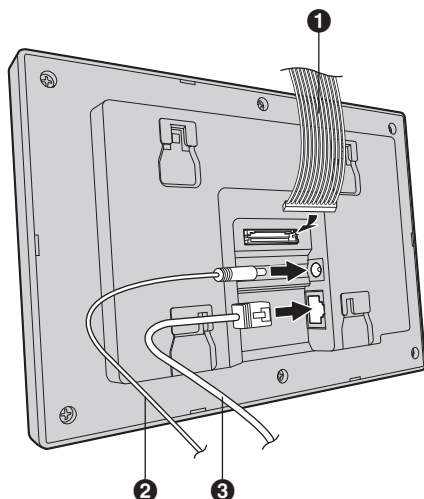

- 1 12-pin terminal cable
- 2 DC plug from power supply unit
- 3 LAN cable

#### Note:

- Refer to 12.9 Wiring schematic (Page 38) for connection diagrams.
- Refer to 12.10 Wire and cable specifications (Page 38) for information on the type and length of wires that can be used.

## 12.8 Connecting external devices

Up to 6 external devices can be connected to the room monitor. External devices are connected to the room monitor by using the 12-pin terminal cable.

### Connecting devices to the 12-pin terminal cable

1. Cut the 12-pin terminal cable in half.
  - Only one of the connectors is needed.
2. Strip 5 mm from the ends of the wires that will be used to connect to the devices.
  - Strip only the wires that will be used.
  - Refer to the diagram below for information about which type of device should be connected to which wires.
3. Solder the ends of the wires coming from the device to the corresponding wires of the 12-pin terminal cable. Use an insulation sleeve to insulate the wires.
4. Insulate any exposed wires of the 12-pin terminal cable that are unused.

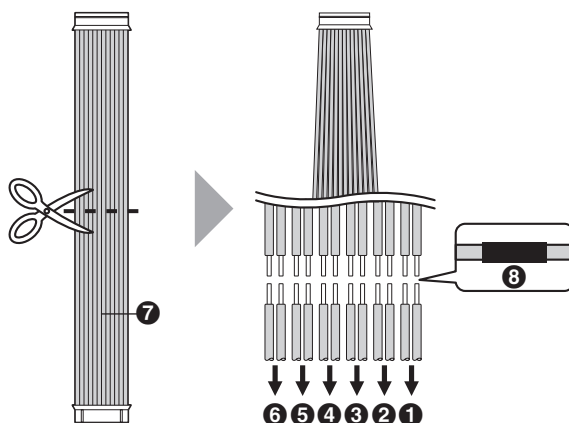

- 1 Connect to urgency button
- 2 Connect to emergency button
- 3 Connect to doorbell
- 4 Connect to device #4 (type is programmable)
- 5 Connect to device #5 (type is programmable)
- 6 Connect to device #6 (type is programmable)
- 7 12-pin terminal cable
- 8 Insulation sleeve

## 12. Installation

### 12.9 Wiring schematic

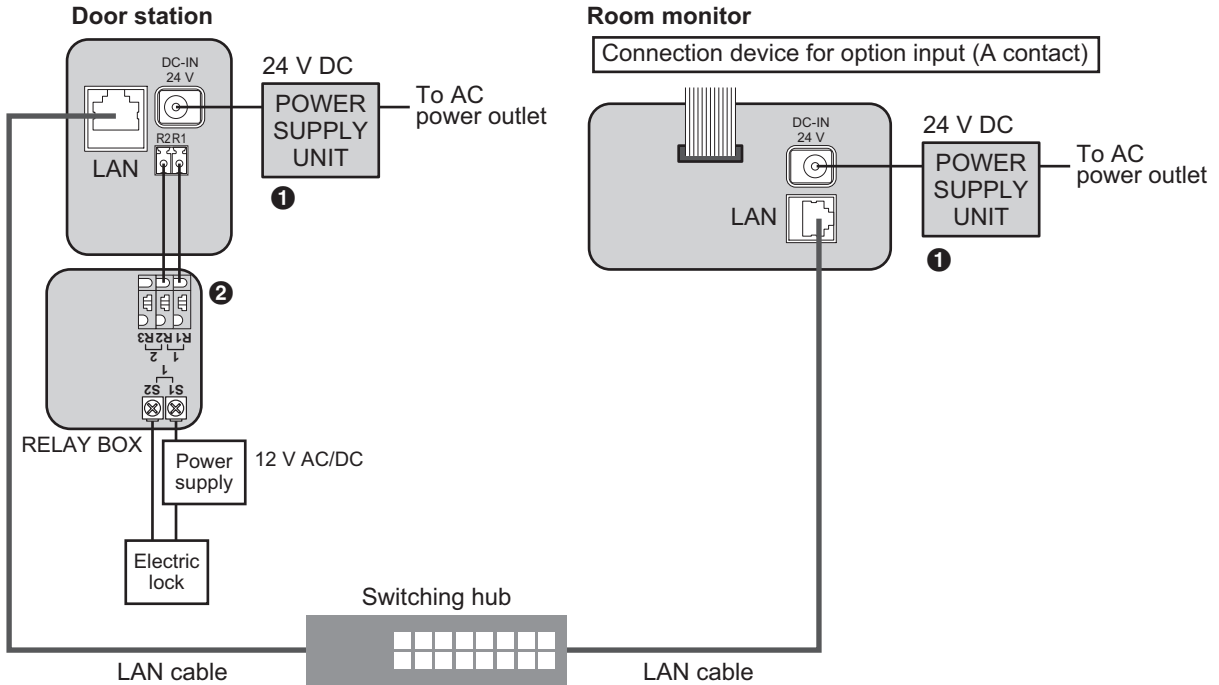

- ❶ If the switching hub does not support PoE, a power supply unit (VL-PS240; sold separately) is required.
- ❷ When connecting an electric lock (user supplied), a relay box (VL-RLY1; sold separately) is required.

### 12.10 Wire and cable specifications

Wiring run		Specifications	Max. length
Room monitor	↔ Switching hub	Cat-5e or higher, stranded, twisted pair, straight	100 m
Power supply unit	↔ Room monitor	0.65 mm (22 AWG)	approx. 10 m
		2 mm (12 AWG)	approx. 20 m
Power supply unit	↔ AC power source	1.2 mm (17 AWG)	No requirement
		2 mm (12 AWG)	
12-pin terminal connector	↔ External device	0.5 mm (24 AWG)	According to specification of connected device.
		1.2 mm (17 AWG)	

#### Note the following when selecting wiring

- For all wiring (except network wiring), use 2-conductor (solid copper) wiring with a PE (polyethylene)-insulated PVC jacket.  
Mid-capacitance, non-shielded wiring is recommended.
- A certified power supply wiring has to be used with this equipment. The relevant national installation and/or equipment regulations shall be considered. A certified power supply wiring not lighter than ordinary polyvinyl chloride flexible wiring according to IEC 60227 shall be used.

---

## 12.11 Initial setup for room monitors

The first time the room monitor is turned on, it will automatically attempt to download its configuration file over the network from the computer being used for PC programming.

- 1 Make sure the computer used for PC programming is connected to the network.
- 2 Connect the room monitor to a power source.
  - The room monitor turns on automatically when it receives power from the LAN cable or the power supply unit.

### 3 **If room monitors were identified by their MAC addresses during PC programming**

Wait for the room monitor to download its configuration file from the computer used for PC programming.

### **If room monitors were identified by room number during PC programming**

Enter the room monitor's room number when prompted. The room monitor will then attempt to download its configuration file from the computer used for PC programming.

**Panasonic Corporation**

1006, Oaza Kadoma, Kadoma-shi, Osaka 571-8501, Japan

<http://www.panasonic.com>

© Panasonic Corporation 2017

**PNQP1323ZA** C0317MG0